

0 to 30
Months

Carrying Capacity
up to 20 kg

User's Manual

Babyhug Visby Cot Bed

Style Code : NUBF021

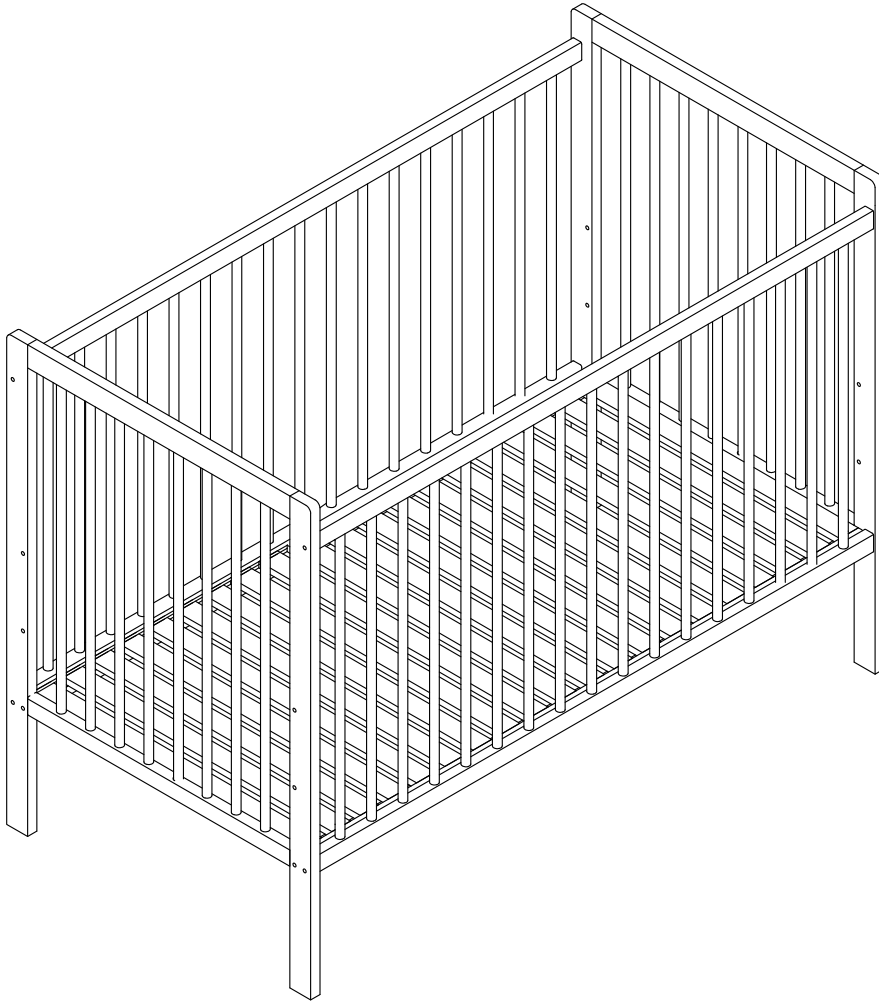

babyhugTM

baby furniture

- Sturdy Frame
- 3 Levels of Base Height Adjustment
- Child-Friendly Paint

Please read the instructions carefully before use and keep this manual for future reference.

Assembly Instructions

Contents:

- 1a Head Board : 1
- 1b Foot Board : 1
- 2 Side Rail : 2
- 3 Base : 1
- M6*60 mm Bolts : 12
- Barrel Nuts : 12
- Plastic Washer : 12
- Allen Key : 1

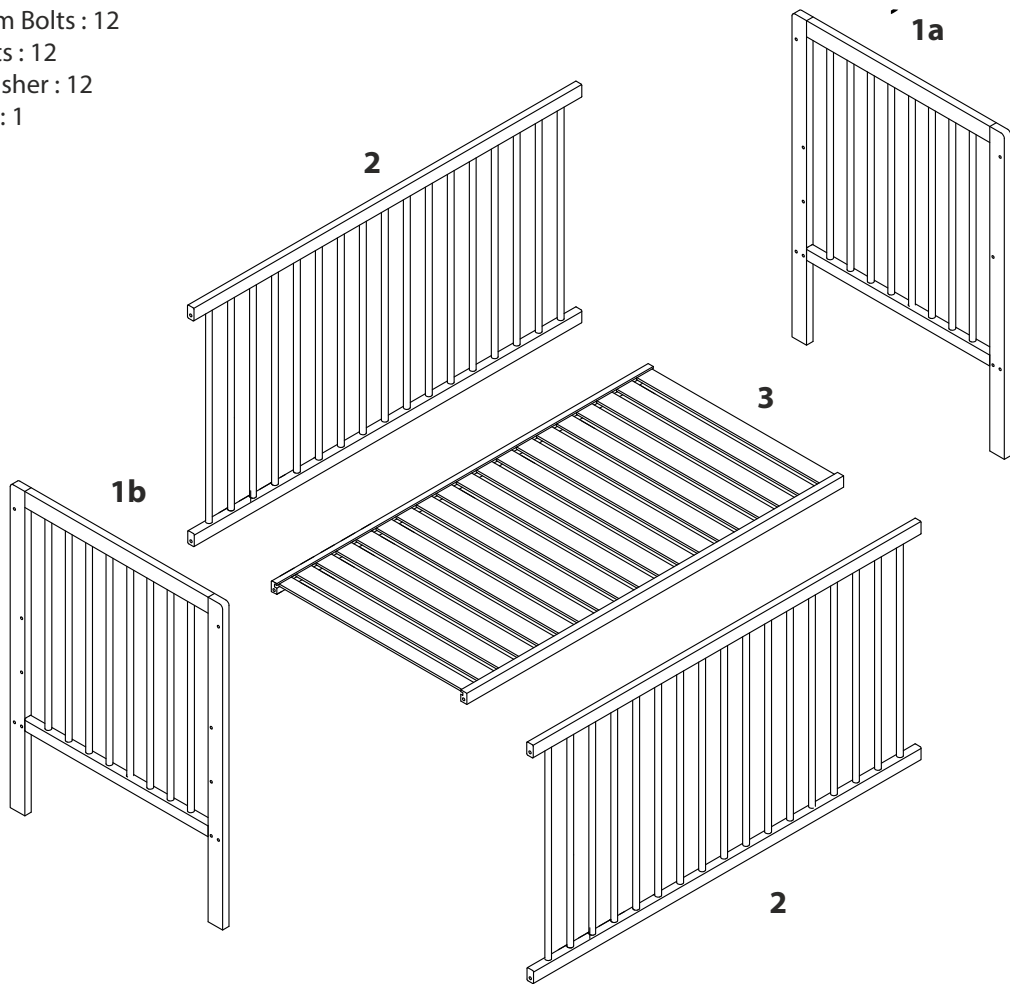



A - Bolts	B - Barrel Nut	C - Plastic Washer	D - Allen Key
 <p>M6X60</p>			
X12	X12	X12	X1

Figure 1

- As shown in figure 1, position the base at the preferred height; lower; middle or upper and insert the bolts part way to stop it from moving
- Insert two barrel nuts into the holes in one corner of the base and align the slots with the bolts (M6*60 mm)
- Once aligned, screw the bolts and plastic washer into the barrel nuts, but do not fully tighten at this stage. Repeat the same process for the other corners

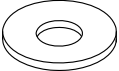
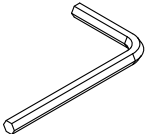
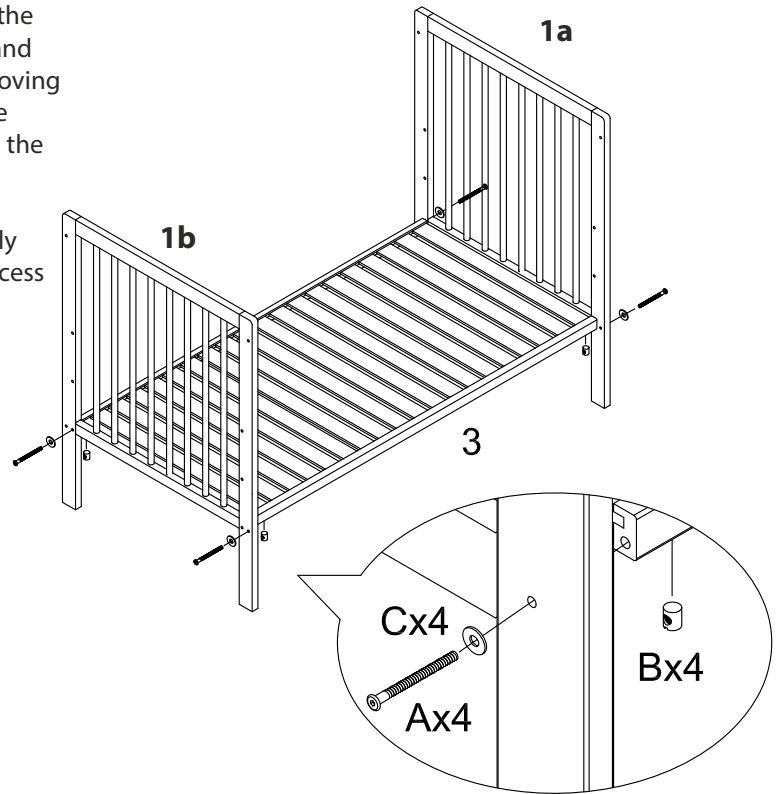
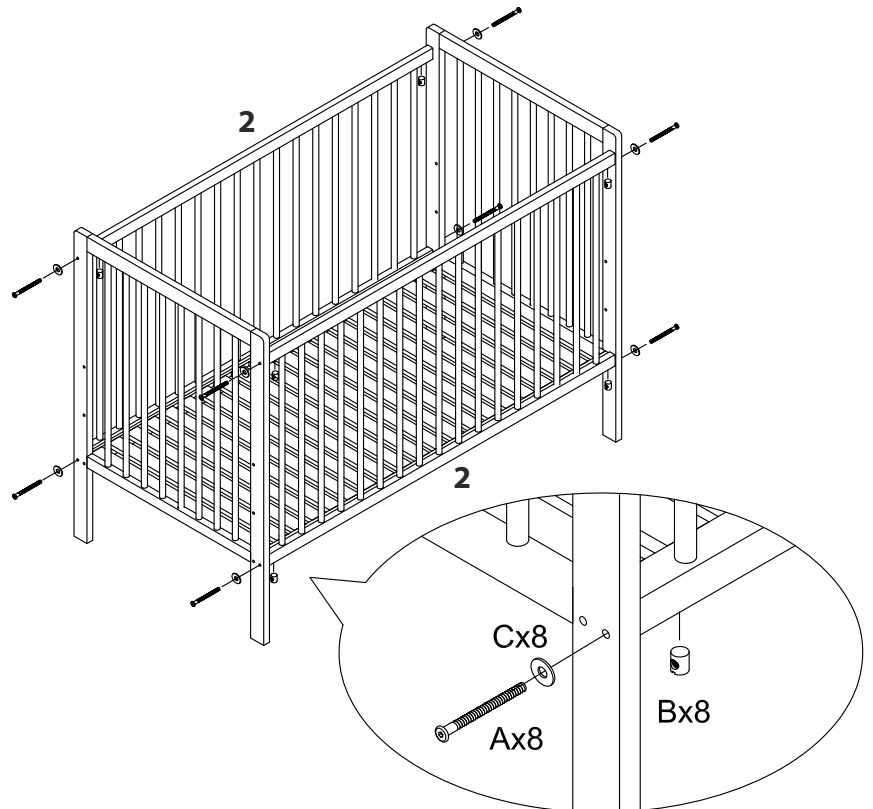

Figure 2

- As shown in figure 2, attach the side rail of the cot and use bolts (M6*60 mm), plastic washer and one barrel nut at each corner to fit them into place. Fully tighten all the bolts to keep all parts in place



Warning:

- Of the 3 base heights, the highest one should be used till the baby learns to sit up. The lowest level is the safest option for babies as soon as they are old enough to sit up by themselves
- Do not leave anything in the cot that could present a danger of suffocation or strangulation
- Place the cot away from objects that could provide a foothold for the child to climb on
- Do not use more than one mattress in the cot
- Do not place your cot in the vicinity of an open fire and other sources of heat, such as electric radiators or gas fire
- The mattress should not be thicker than 10 cm
- While at the lowest base position ensure that the surface of the mattress and the upper edge of the cot frame are at least 50 cm apart
- While at the highest base position ensure that the surface of the mattress and the upper edge of the cot frame are at least 20 cm apart
- The cot bed is suitable for a mattress of 120 cm in length and 60 cm in width
- The mattress should fit snugly into the cot. There should not be more than 3 cm gap between the mattress and the cot
- When the child is able to climb out of the cot, the cot should no longer be used for that child

Maintenance:

- Regularly check that all fittings and components of the cot are fully tightened and in working order
- Check for damage which could render your cot unsafe
- To clean use a soft cloth, avoiding the use of strong detergents or abrasives

Imported & Marketed By

Brainbees Solutions Pvt. Ltd.
Corporate & Registered Office Address:
Rajashree Business Park, Plot No: 114,
Survey No. 338, Tadiwala Road,
Near Sohrab Hall, Pune 411 001

Customer Care :

☎ 020-30556310
✉ customercare@brainbees.com

Made in PRC